











## MT 2020S

|  |         |   |   |   |                                    |
|--|---------|---|---|---|------------------------------------|
|  | 20,20 m |  | 18,20 m   |  | 7,80 m (200 kg)<br>10,10 m (80 kg) |
|  | 200 kg  |  | 1,40x0,70x1,10 m  |  | 90°+90°                            |
|  | 360°    |  | DS<br>Stabilizzatori a discesa in sagoma<br>Stabilisateurs dans le gabarit<br>Straight line stabilizers<br>Stützen innerhalb der Fahrzeugbreite |  | 3,5 t                              |

# MT2020S

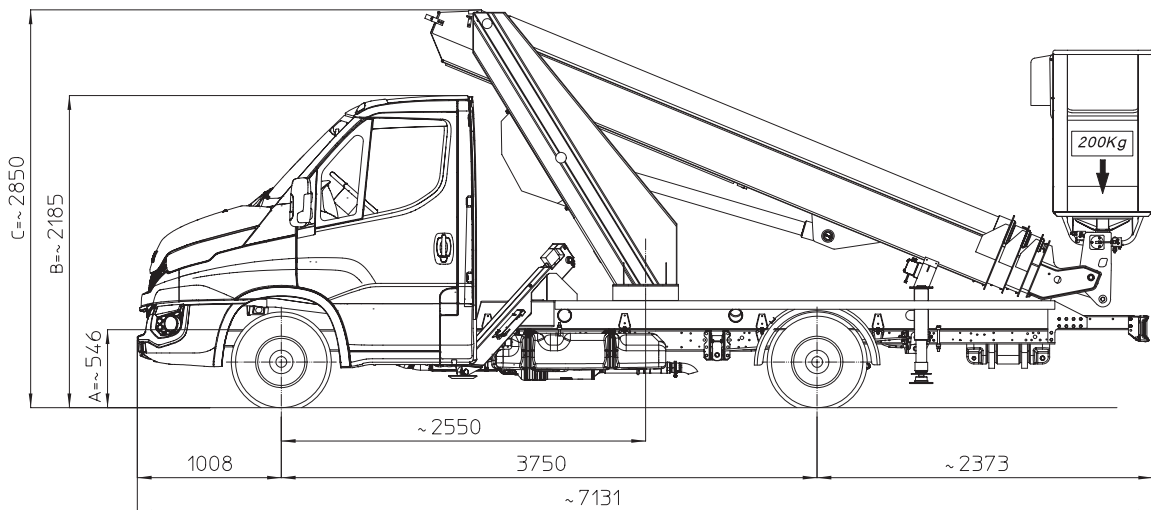
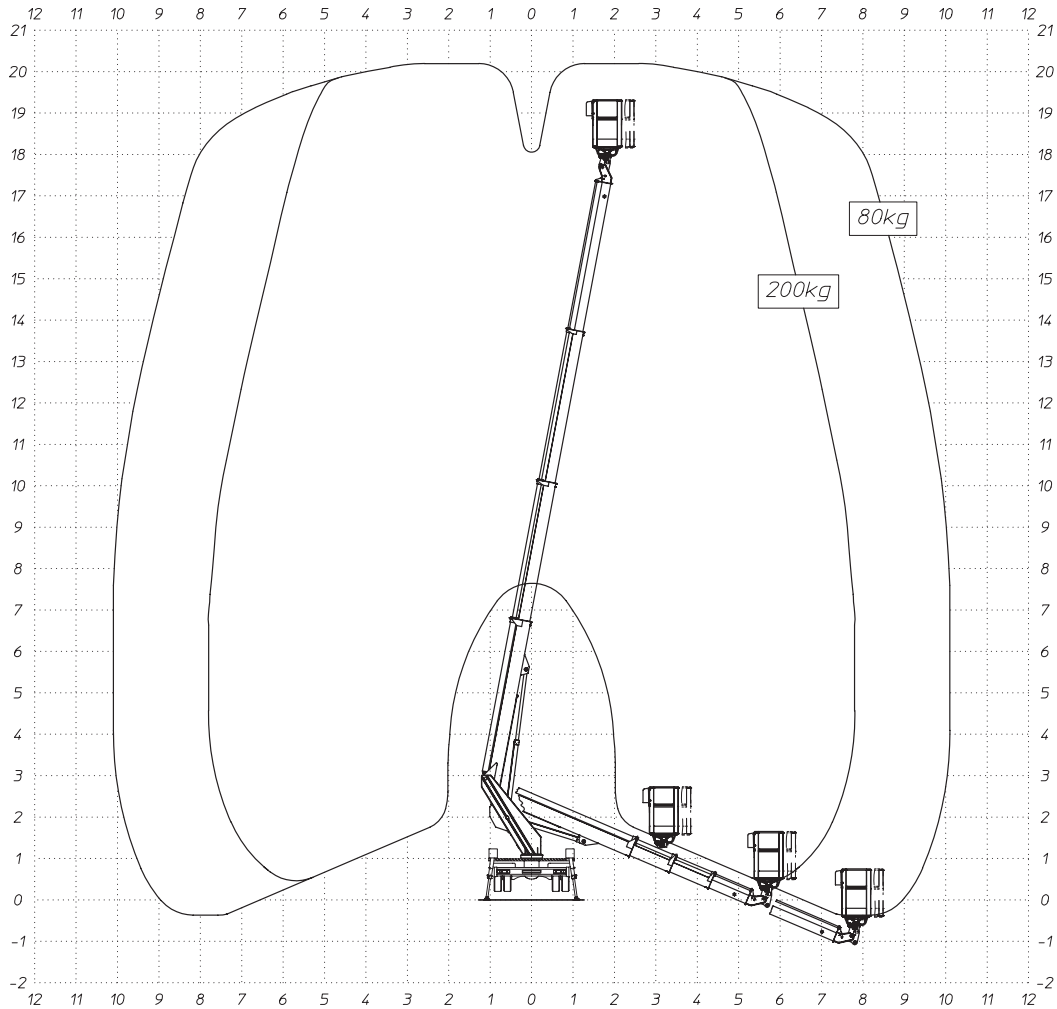

## MULTITEL PAGLIERO S.P.A.

Strada Statale, 114  
12030 MANTA (CN) - ITALY  
Tel. +39 0175 255211- Fax +39 0175 255255  
info@pagliero.com

### Filiali

Corso Piemonte, 54  
10099 S.MAURO T.SE (TO) - ITALY  
Tel. +39 011 2236792 - Fax +39 011 2236761

Via dell'Offelera, 106  
20861 BRUGHERIO (MB) - ITALY  
Tel. +39 039 883393/4 - Fax +39 039 2872140

## MULTITEL INTERNATIONAL SAS

87, rue du Morellon  
38070 ST. QUENTIN FALLAVIER - FRANCE  
Tel. +33 (0)4 74 94 63 19 - Fax +33 (0)4 74 94 46 97  
info@multitelinternational.com

## MULTITEL EXPORT SALES GmbH

Carl-Zeiss-Straße, 34  
52477 ALSDORF - DEUTSCHLAND  
Tel. +49 (0) 2404 675 580 - Fax +49 (0) 2404 675 58 29  
export@pagliero.com

## MULTITEL UK Ltd

c/o Simmons Gainsford  
7/10 Chandos Street, Cavendish Square - London W1G 9DQ  
info.uk@pagliero.com

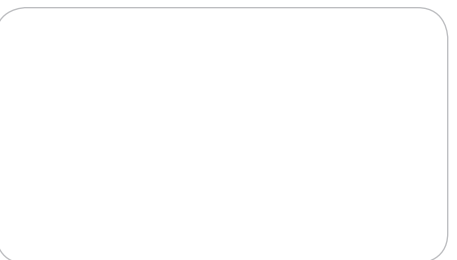

[www.multitelgroup.com](http://www.multitelgroup.com)